

# SPECS. BM1514

REV# 2  
12-19-16

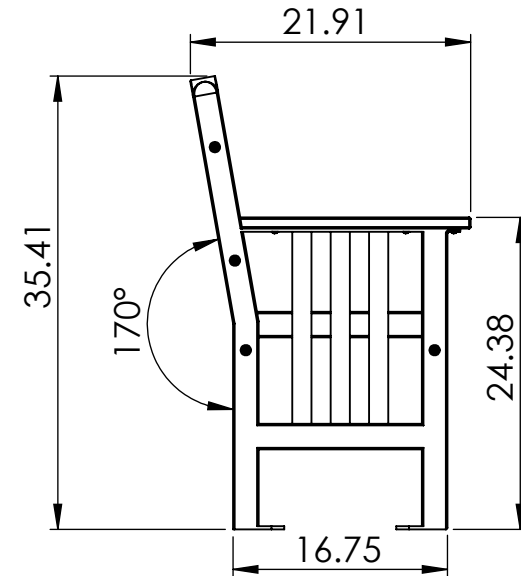
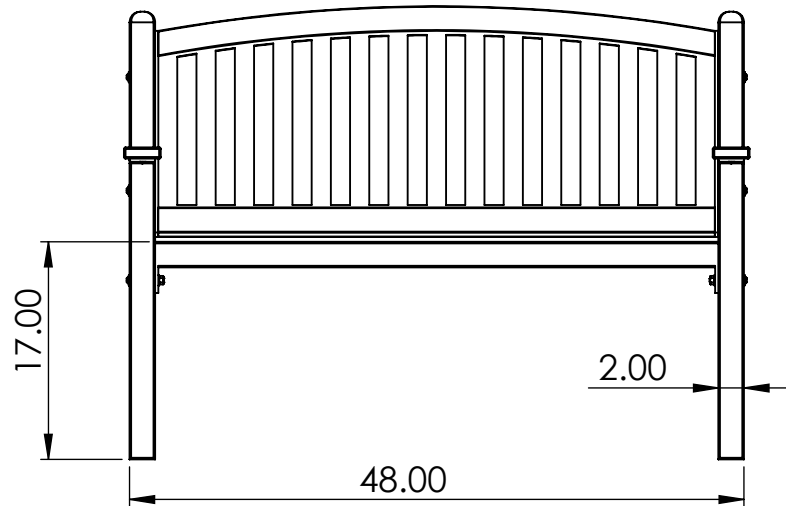
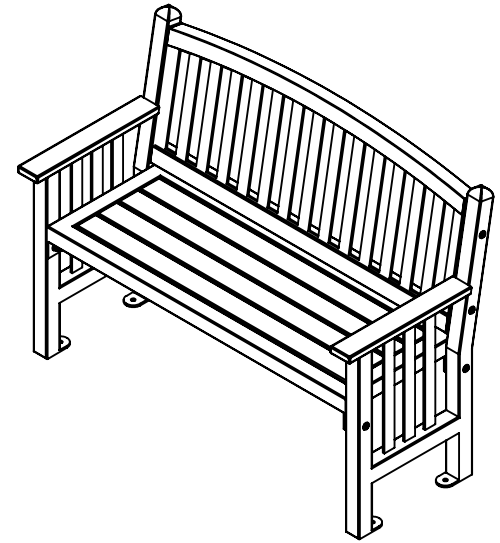
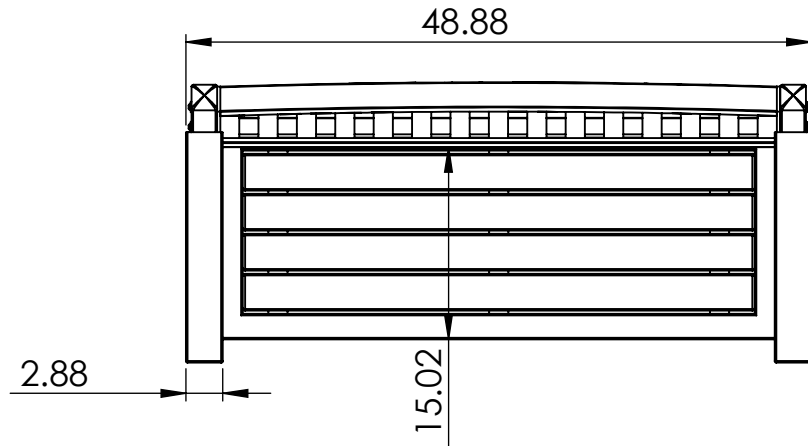

ALL DIMENSIONS SHOWN IN INCHES, UNLESS NOTED