

BENCH SPECIFICATIONS BC1390

REV# 2
1/22/18

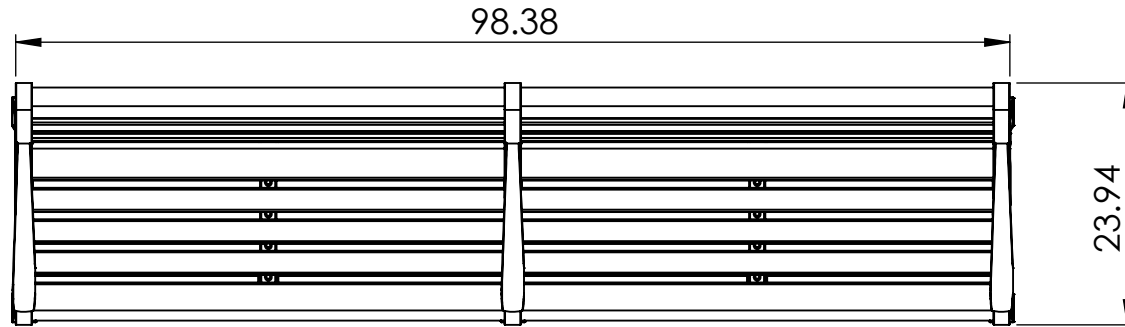

Tear drop board 3.75" x 1.34" 2.88" of flat surface on board
Bull nosed board 3.75" x 1.34" 3.00" of flat surface on board
Square board 2.36" x 1.34"

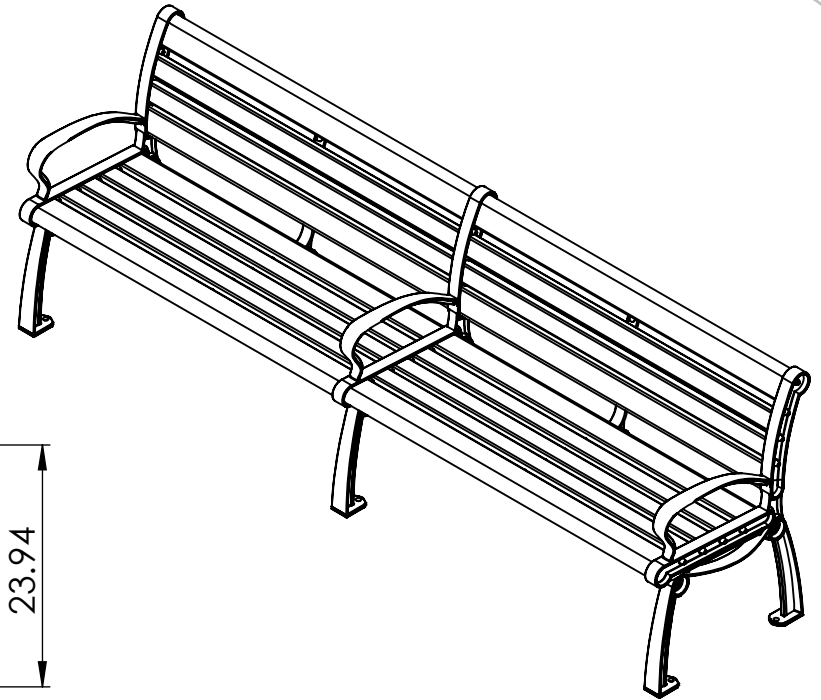
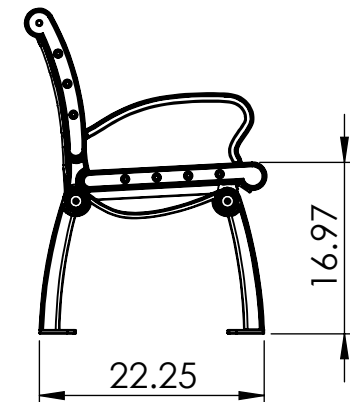
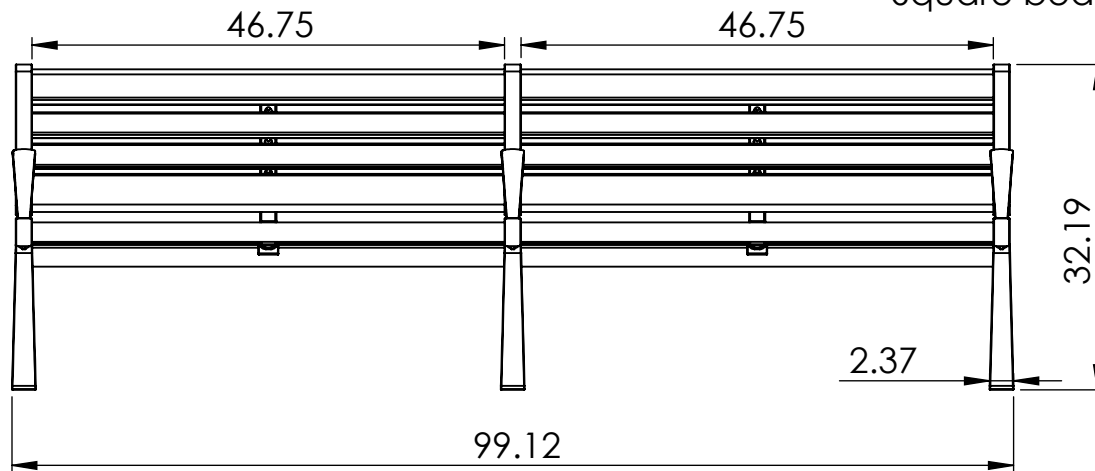

CONSTRUCTION MATERIALS:

Recycled Plastic
Cast Aluminum

HARDWARE:

Stainless Steel

ALL DIMENSIONS ARE SHOWN IN INCHES