

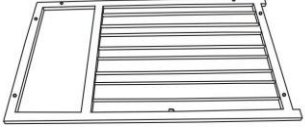

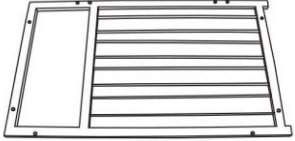

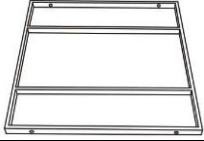

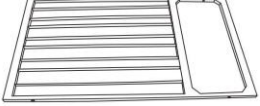

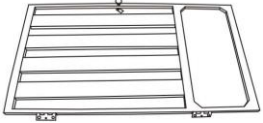

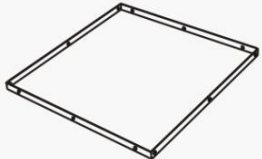

# Assembly Instructions

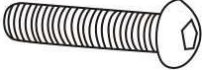
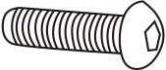
## 30 Gallon Steel Slats Trash Receptacle

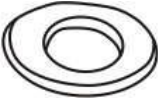
Before assembly, be sure that all components are included.

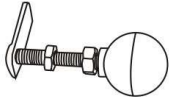
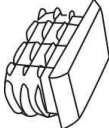
Part List	Description	Qty.	Drawings
A1	Left Side Panel	1	
A2	Right Side Panel	1	
B	Bottom Frame	1	
C	Back Panel	1	
D	Front Door Panel	1	
E	Dome	1	
F	Liner Panel A	2	
G	Liner Panel B	2	
H	Liner Bottom	1	

I	Top Frame	1	
J	Trash Bag Holder	1	
K1	Bolt (M6X25)	4	
K2	Bolt (M6X20)	16	
L	Lock Nut Bolt (M6X12)	20	
M	Flat Washer (M6)	36	
N	Nut (M6)	28	
O	Bolt (M6X12)	4	
P	Lock (Pre-installed)	1	
Q	Leg Cap (15x30) (Pre-installed)	4	
R	Hexagon Wrench	1	
S	Allen Wrench	1	

**Tool required: Allen Wrench and Hexagon Wrench (provided), Screwdriver (not provided)**



## Special Warnings

- We suggest you thoroughly read and follow this simple step-by-step assembly instruction. Portions of the assembly may be easier with two people.
- Do not discard any of the packaging until you have checked that you have all the parts.
- Plastic polybags can be dangerous. Keep the bags away from babies and children to avoid danger of suffocation.
- Set out all parts on a clear, flat and level surface.
- Assemble all parts loosely before tightening any bolts.
- Check and ensure that all bolts are fully tightened when finished assembling, but **DO NOT** over tighten.

### Assembly Steps:

**Step # 1:** Place Bottom Frame (B) on a clean and flat surface. Attach Left Side Panel (A1) to Bottom Frame (B) using 2 Bolts (K2) and 2 Flat Washers (M). Repeat the same step assemble the Right Side Panel (A2) **Hand tighten!**

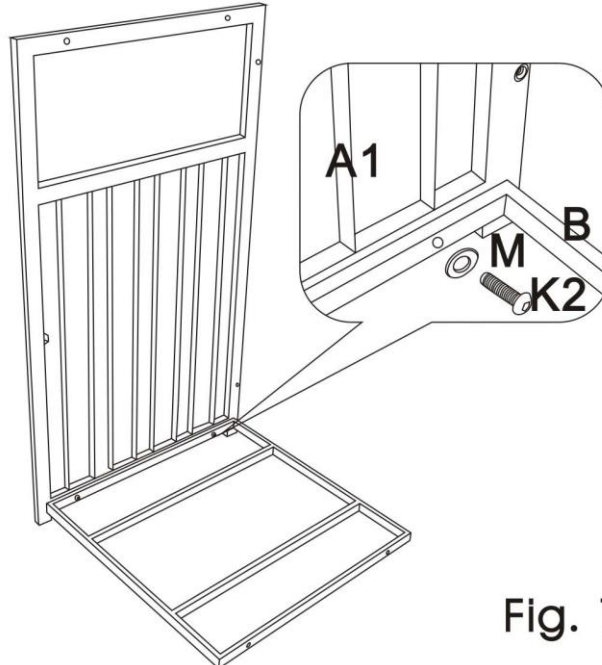

Fig. 1

**Step # 2:** Attach the Back Panel (C) to Left Side Panel (A1) Right Side Panel (A2) and Bottom Frame (B) by using 4 Bolts (K1) and 4 Flat Washers (M). **Hand tighten!**

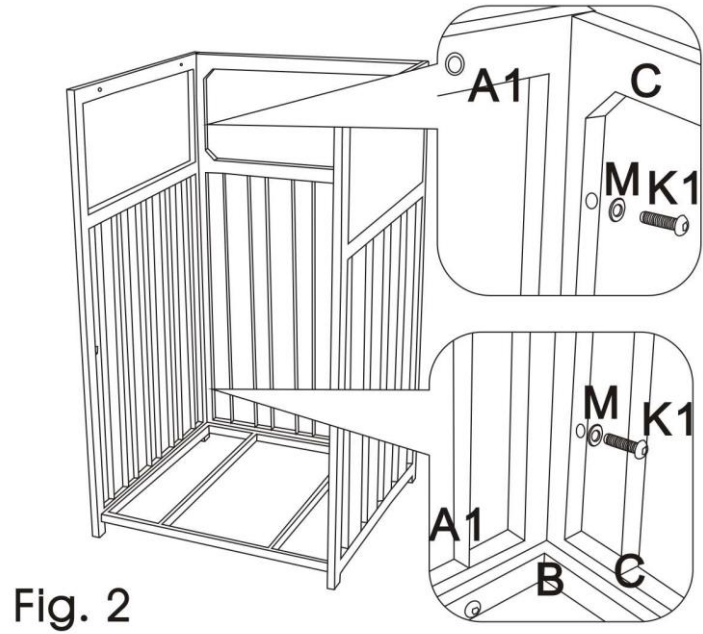

Fig. 2

**Step # 3:** Place Dome (E) onto the assembled outer frame and secure it by using 4 Bolts (L) **Hand tighten!**

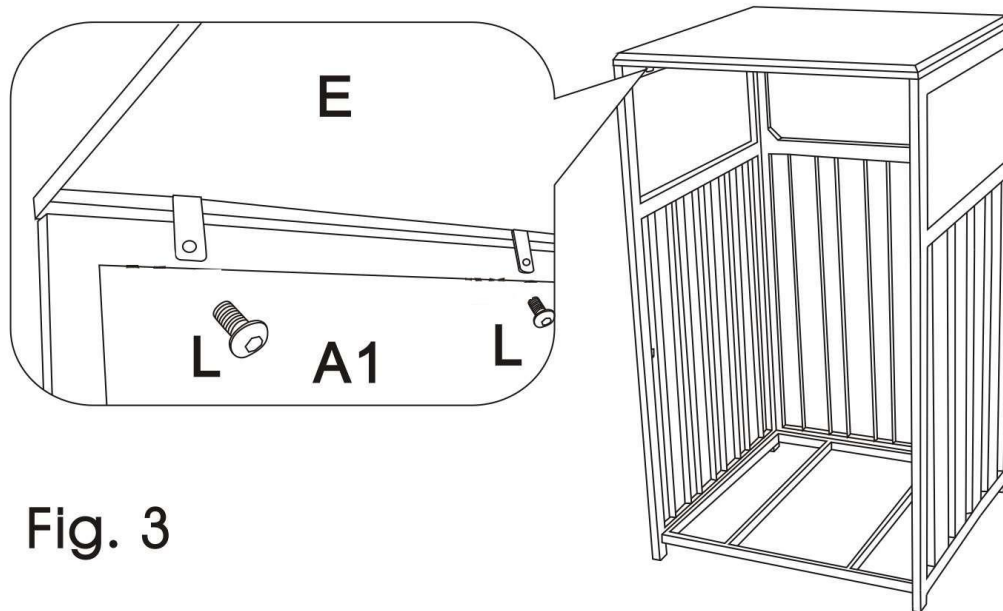

Fig. 3

**Step # 4:** To assemble the liner, attach 2 Liner Panels B (w/o handle) (G) to Liner Bottom (H) on the opposite side by using 6 Bolts (L), 6 Flat Washers (M) and 6 Lock Nuts (N). Then attach 2 Liner Panels A (w/ handle) (F) to Liner Bottom (H) on the opposite side by using 6 Bolts (L), 6 Flat Washers (M) and 6 Lock Nuts (N). Secure four Panels in the middle with 4 Bolts (L), 4 Flat Washers (M) and 4 Lock Nuts (N).

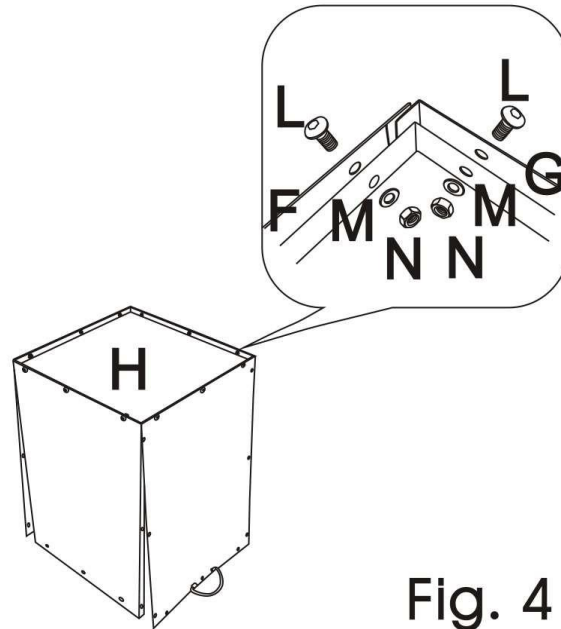

Fig. 4

**Step # 5:** Then turn the assembled inner bucket over so that it sits securely on a flat surface. Insert Top Frame (I) to bucket, and secure it to panels by using 12 Bolts (K2), 12 Flat Washers (M) and 12 Lock Nuts (N). **Tighten all the bolts and nuts by Allen Wrench (S) and Hexagon Wrench (R) (provided), but DO NOT over tighten!** Now, you can insert 30 gallon trash bag over the inner bucket and secure in place using Trash Bag Holder (J).

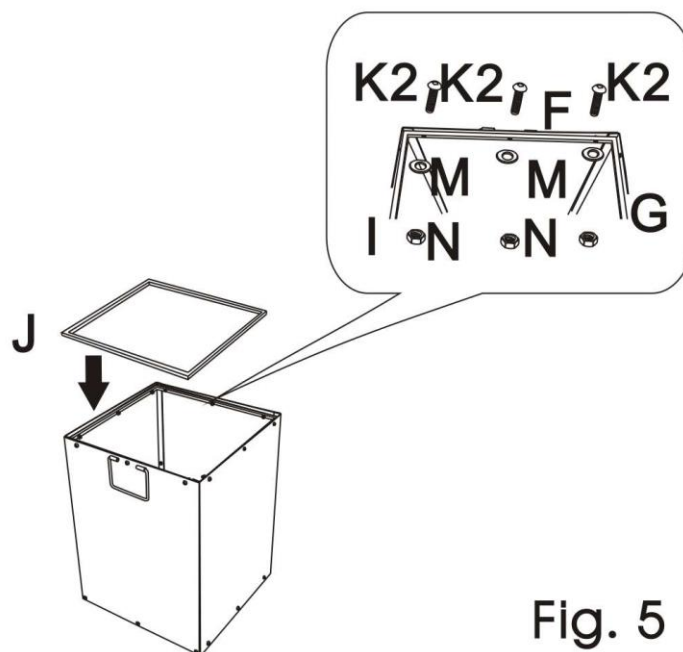

Fig. 5

See detailed instruction on the last page

**Step # 6:** Attach Front Door Panel (D) to the assembled outer frame and secure it by 4 Bolts (O) with Screwdriver (not provided).

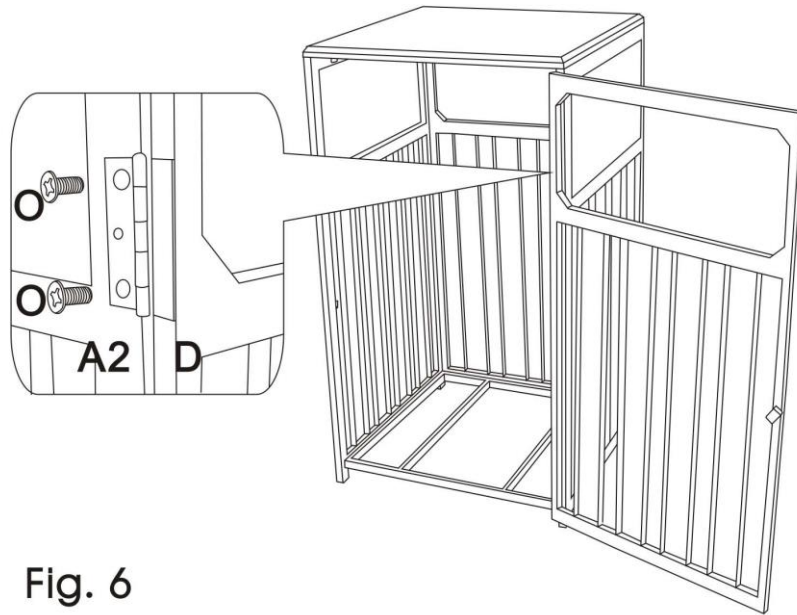

Fig. 6

**Step # 7:** Now you can slide inner bucket into outer frame as shown below. Your product is ready for use!

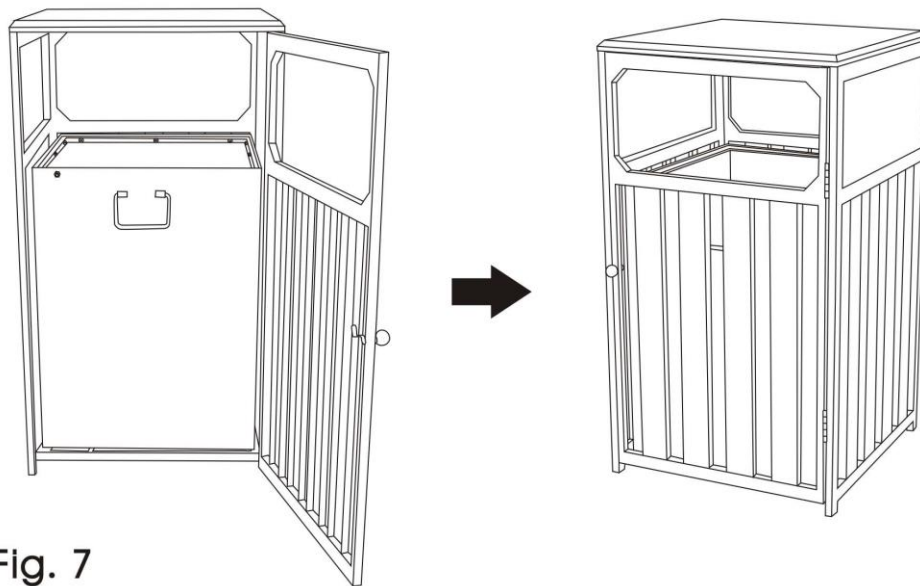

Fig. 7

Assembly instruction for Step 5

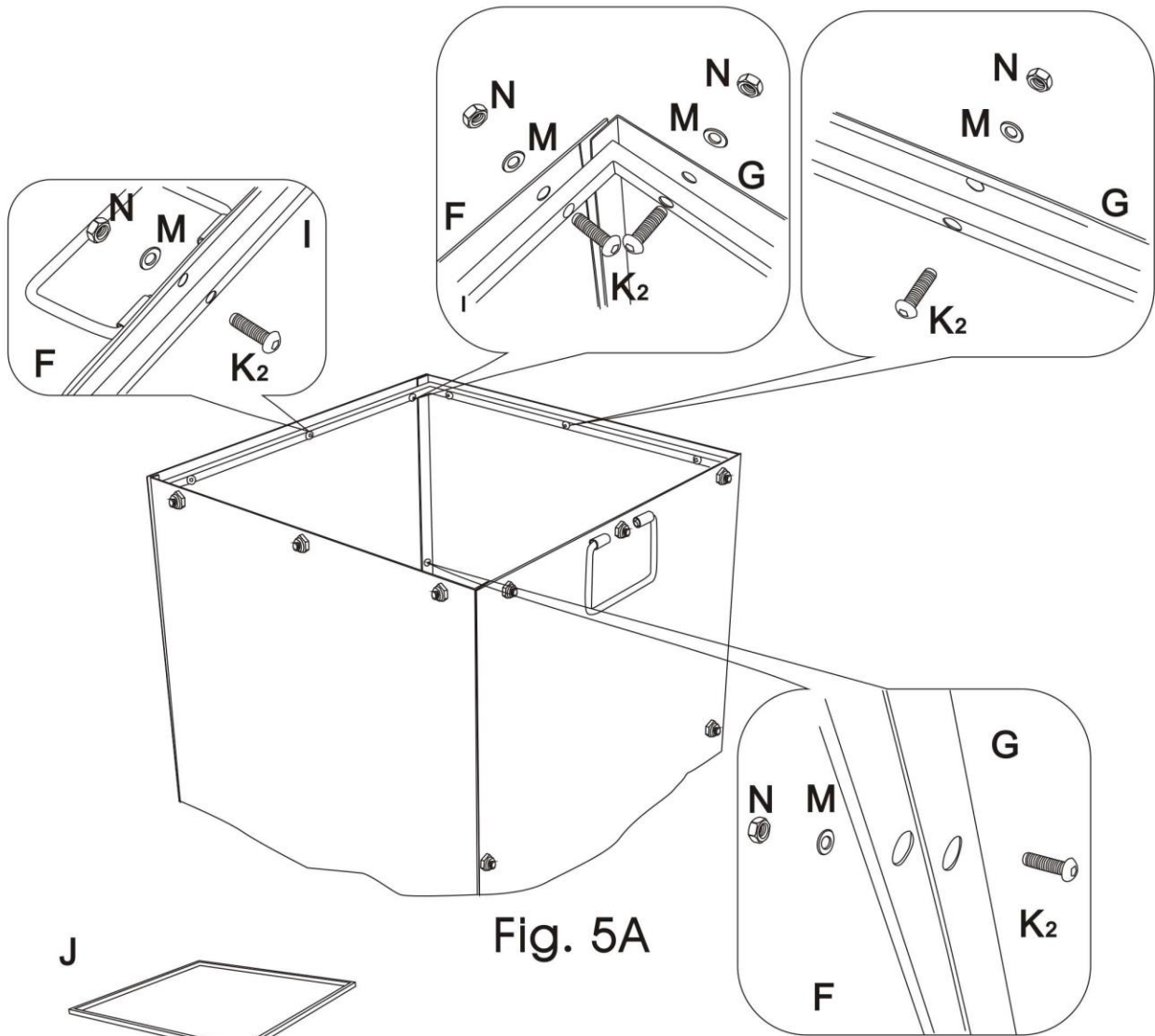

Fig. 5A

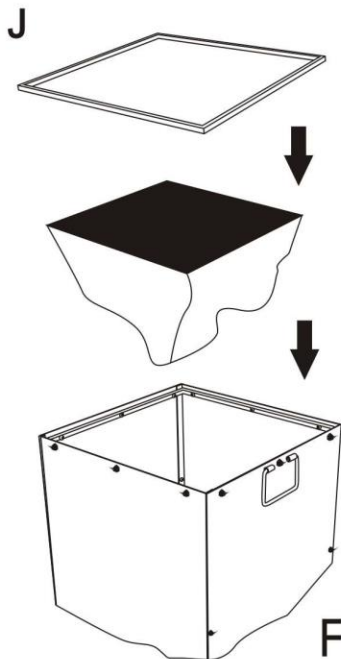

Fig. 5B

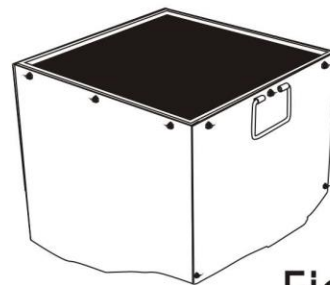

Fig. 5C