

# BENCH SPECIFICATIONS

BC1934

REV# 1  
2/24/2017

**TOP**

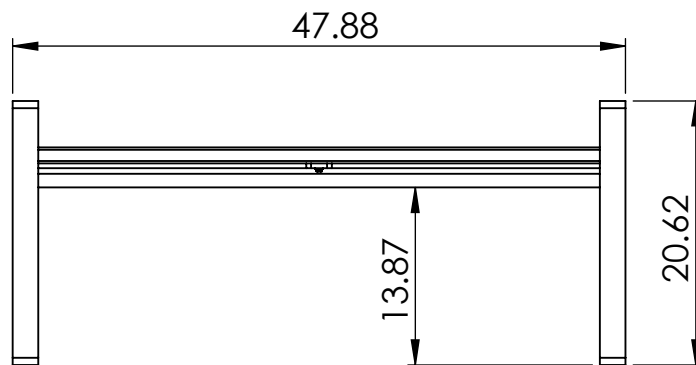
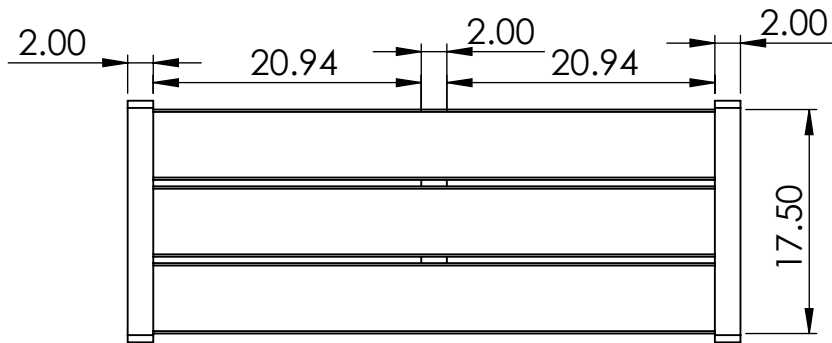

**FRONT**

**CONSTRUCTION MATERIALS:**  
Recycled Plastic  
**HARDWARE:**  
Stainless Steel

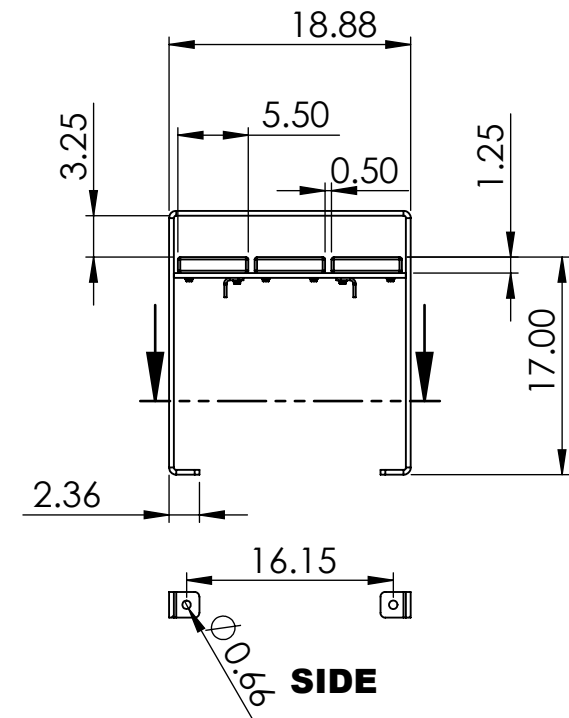
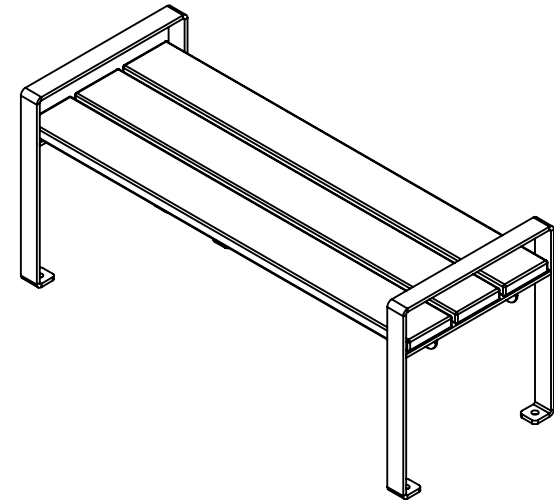

**SIDE**

ALL DIMENSIONS ARE SHOWN IN INCHES